



NavDP4000 Series Dynamic Positioning Systems

NavDP 4000 Series – The Professional’s Choice

Navis Engineering OY, founded in 1992, is one of the few world experts in dynamic positioning. Having supplied DP systems for more than 400 vessels in 12 years, Navis is recognized as a reliable provider of “turn-key” solutions for high quality Dynamic Positioning Systems.

High efficiency, a profound understanding of every customer’s needs as well as global market trends, combined with the outstanding quality, reliability and simplicity of the systems – this is what our company stands for.

Sharing experience – Navis Engineering is a member of



Your approved DP solution -



The NavDP 4000 Series is a new generation of Navis Dynamic Positioning Systems combining the best qualities of the previous system, the Navis IVCS Series, with the latest achievements in technology and recent design ideas gained from experienced users’ feedback, recent Class rules changes and market trends.

The Navis NavDP4000 series system is fully flexible in configuration design and can be supplied as a stand-alone or integrated solution tailored to the specific needs of every customer, be it a high-end newbuilding or a retrofit vessel.

Having a lot of retrofit projects in our reference list, we always find the optimal solution to ensure the best results in any given situation.

The modular architecture of the Navis NavDP 4000 Series allows for integration with various types of propulsion/thruster and power management systems. The sensors and reference system are selected according to Class rules and vessel mission.

Typical applications for the NavDP 4000 series include:

- Offshore supply vessels
- Crew boats
- Anchor Handling Tug Supply vessels
- Diving Support Vessels
- Heavy Lift Semi-Submersible Vessels
- Oil and Gas shuttle tankers
- Dredgers
- Cruise ships and mega-yachts
- Hydrographic survey vessels
- Buoy tenders
- Cable layers



NavDP4000 Series Highlights

This section provides an overview of selected features of the Navis NavDP 4000 Series design. Since the functionality and system design of DP systems is largely dictated by Class requirements, this document is not intended to list all the features available in our system

ADVANCED ERGONOMIC DESIGN OF WORKSTATIONS

Alongside the standard NavDP 4000 Series workstation console, we can offer our new integrated DP control chair solution for high-end newbuildings with the set of functionality fitted to the operator's needs. Both solutions have been designed following Det Norske Veritas (DNV) rules and using experienced DP operators' feedback to ensure a friendly environment for the operator as well as for the service staff.



USER INTERFACE DESIGN CONCEPT

The user interface of the Navis NavDP 4000 Series has been developed in cooperation with experienced DP operators and ergonomic experts. Priorities have been given to clear and unambiguous presentation of information, timely error-free access to functions, and simplicity.

Although the system is based on the Windows operating system, the design of the new user interface does NOT accept standard "Windows-like" controls. Instead it uses "device-like" controls.

The combination of the high quality marine touch screen and the new generation DP control panel equipped with a high-resolution color display has as few as a dozen of buttons and controls, providing a unique intuitive and self explanatory user interface.

Voice alarms and a messaging function help to maintain a high level of awareness in any situation.

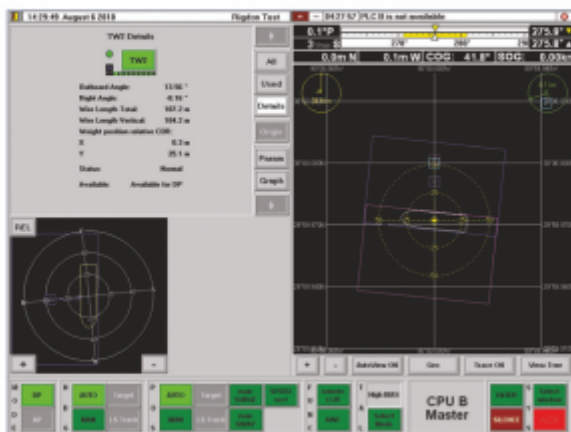

THRUST ABILITY DIAGRAM

Navis Engineering has developed unique functionality in Dynamic Positioning Systems.

For a particular thruster configuration, the Thrust Ability Diagram shows in real time all possible combinations of control forces in the surge and sway axes for a given value of the rotational control moment and thruster availability and/or allowed power load.

Since each pair of forces can be considered as a vector, the diagram is a bounded set on a plane where every point corresponds to a particular combination of control forces achievable.

This set of forces depends on how much is demanded on the rotational moment. Should any change happen to parameters or conditions, the diagram is automatically updated on the screen.

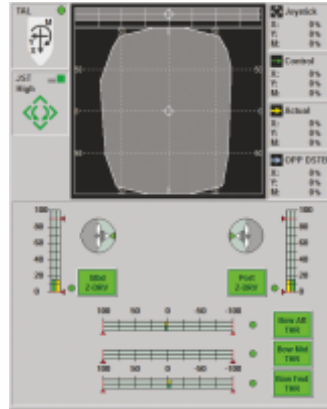

All thrusters active

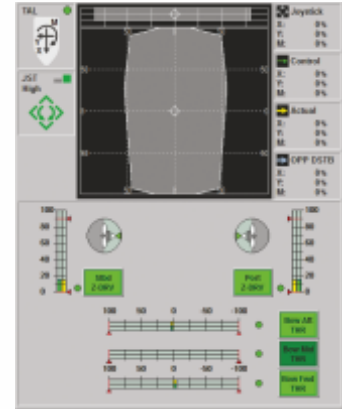

Port Engine Lost

If the desired force vector goes beyond the boundary of the set, the actual force vector is on the boundary, and the system tries to minimize the difference.

POWER MONITORING AND BLACKOUT PREVENTION

Information from the Power Management System and Thruster System is continuously received by the NavDP4000, including the load on each generator and thruster, the way the thrusters and generators are connected to the power buses, and the way the power buses are connected to each other.

The NavDP4000 monitors the power load to avoid blackouts. In case a blackout might occur, the NavDP4000 computes new demands on the force and moment, which satisfy the power limitations and ensure proper operation for each generator, and assign a new thrust to each thruster, so that the effect on the position and heading control is minimized. The Power Management Function is active in all modes.

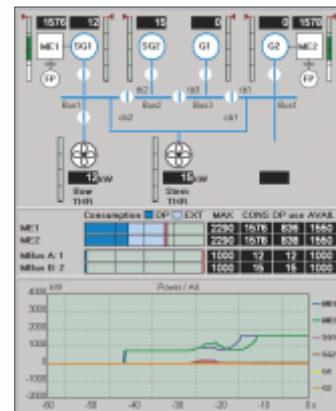

SYSTEM MONITORING

The system constantly controls the state of its components (PLCs, computers, buses, etc.), sensors, thrusters, generators and power circuits in real time. The respective information is also available for the operator in the form of messages and also as an easy-to-understand diagram, which can be displayed on the screen on request. The diagram uses different colors to indicate the state of the components and the connections between them. If a component or a connection changes its state (i.e. becomes active or inactive or fails), the color with which the component is displayed also changes.

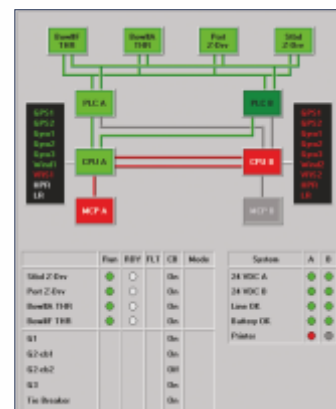

NavDP4000 Series Highlights

TREND VIEW

In the NavDP4000's Trend View window the operator is able to trace the system performance history for three different sets of parameters at a time.

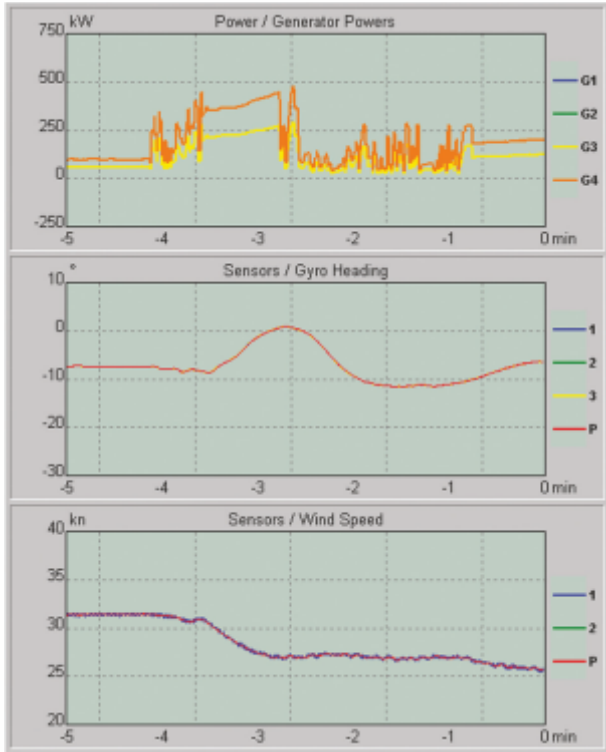

Trend View Window



Multi-Target Following Window

MULTI-TARGET FOLLOWING

The Target Following mode is used to follow a target or to position the vessel within a pre-defined range around the target selected. The NavDP4000 provides both single- and multi-target following modes. In the Multi-Target mode the data on the range of the multi-target group is received from the first target, while the second target provides the information about the group bearing.

CONSEQUENCE ANALYSIS

For DP2 Class vessels, the Consequence Analysis function makes it possible to determine whether the vessel is able to maintain its position in the case of a worst-case failure, the most typical of which are thruster failure, generator failure and the circuit breaker/tie breaker failure.

Possible consequence prediction is based on the actual weather conditions, the performance of the enabled thrusters and the power plant (generators, circuit breakers, tie breakers) status.

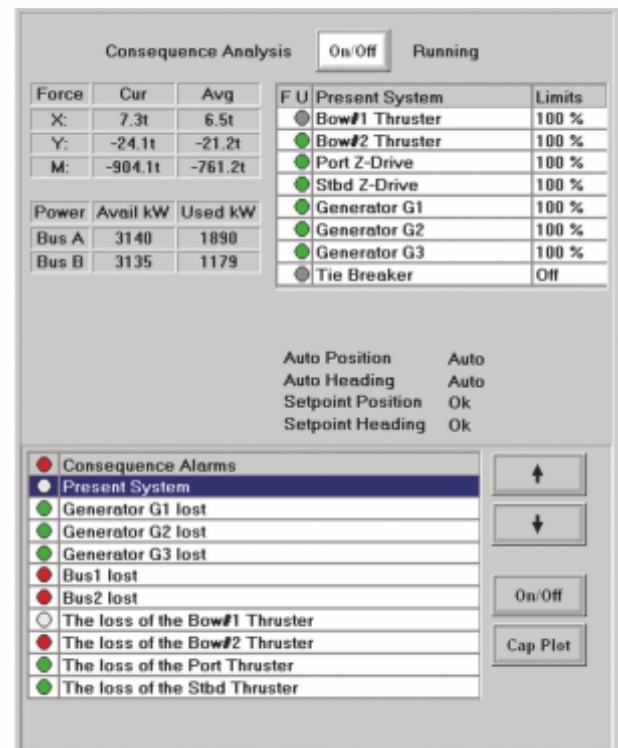

Consequence Analysis Window

SIMULATOR MODE

Each Navis' DP system is delivered with a built-in Simulation Mode functionality that provides simulations for operator training, also making it possible to analyze the vessel's performance changes in different environmental conditions.

Simulations are performed at the DP system control station (console). No additional equipment is required. The simulation mode can only be used when the system is not in use for DP operations.

Starting the simulation session, the operator can set the initial conditions (vessel initial speed, heading, latitude and longitude). The environmental conditions (wind and current speed and direction, wave height and direction, Water depth settings) can also be set.

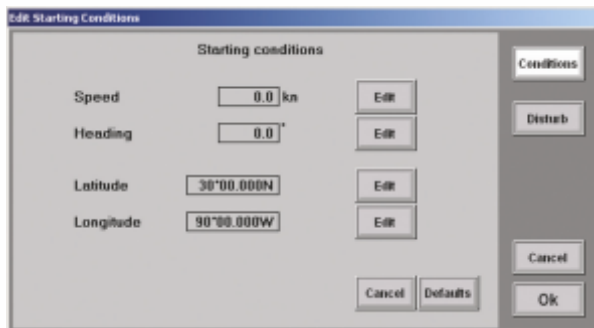

Simulator Mode Screen

CENTER OF ROTATION

For different tasks required during operation of special application vessels, the NavDP4000 provides the functionality of setting different centers of rotation. It can be located either in the ship's center, in the bow or stern, or in any other location manually set by the operator. Whatever COR is used for operation, the system will guarantee the ultimate positioning precision.

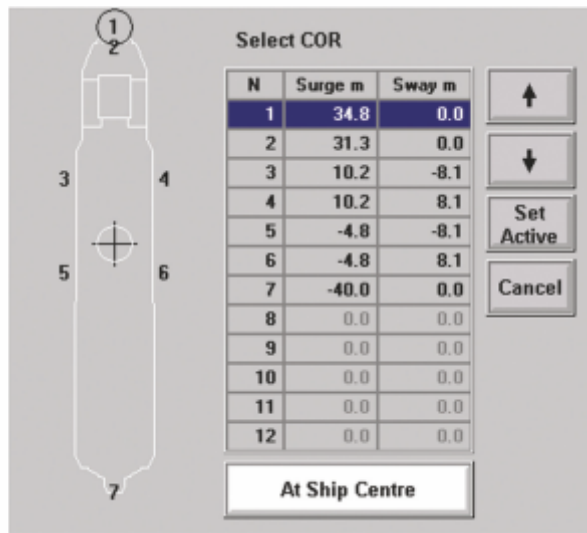

Center of Rotation Screen



Data Logger

The Navis DP features an advanced option for recording, storage and playback of data related to DP operation.

If installed in addition to the conventional Alarm and Event printer required by Class, it insures precise recording of:

- Ship sensor data available for DP
- Position reference system data
- Results of filtering processes
- Thruster commands and response
- PMS information
- System faults
- Operator actions
- Other relevant data

Though recording devices for ship operations are not yet required by IMO or Class, they help the ship-owner in assessment of DP-casualty cases.

NavDP4000 Series Highlights

AUTOPILOT CONTROL MODE

The NavDP 4000 Series is equipped with a built-in fully functional autopilot, which has been type-approved by DNV as a Heading Control System. The Autopilot Mode is used for heading control when the vessel is moving forward. Since it is approved for navigation, it can be used instead of a separate conventional Heading Control System.

The compact panel of the Navis AP4000 DNV-approved autopilot can optionally be used in the forward navigation console as a remote control station for the autopilot if an aft-view Independent Joystick System is installed. Alternatively, a forward-view Independent Joystick System may be used to control the autopilot if particular Class rules permit such a bridge arrangement.

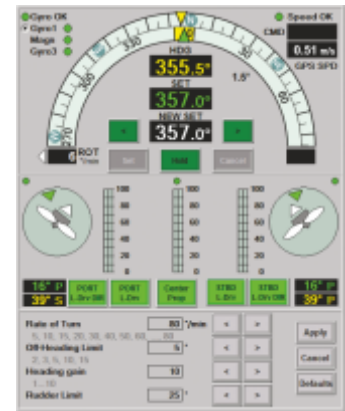

DP Alert System

Navis DAS4000 (DP Alert System) has recently been developed in accordance to the IMCA Guidelines (M 103 Rev 1, December 2007 (Chapter 3.4).

DAS4000 is a means of communication between the DP operator and the personnel of the vessel involved in a DP operation allowing to prevent potential damage in case of a possible equipment failure. Having 3 control modes (Off, Auto, Manual) and supporting up to 7 slave stations in one network, it allows for the DP status levels to be initiated either by the DP system itself (in the Auto mode) or by the DP operator (in the Manual mode).

The 3 status levels that can be generated by DAS4000 are:

- Green or Normal operational status when the equipment is performing safely
- Yellow or Degraded when the DP functionality is degraded due to a sensor/thruster failure
- Red status when position loss is inevitable.

The range of NavDP4000 configurations secures compliance with all the functional and redundancy requirements set by IMO, DNV, BV, LRS, CCS, IRS and RMRS for DP systems of Classes 1-3.

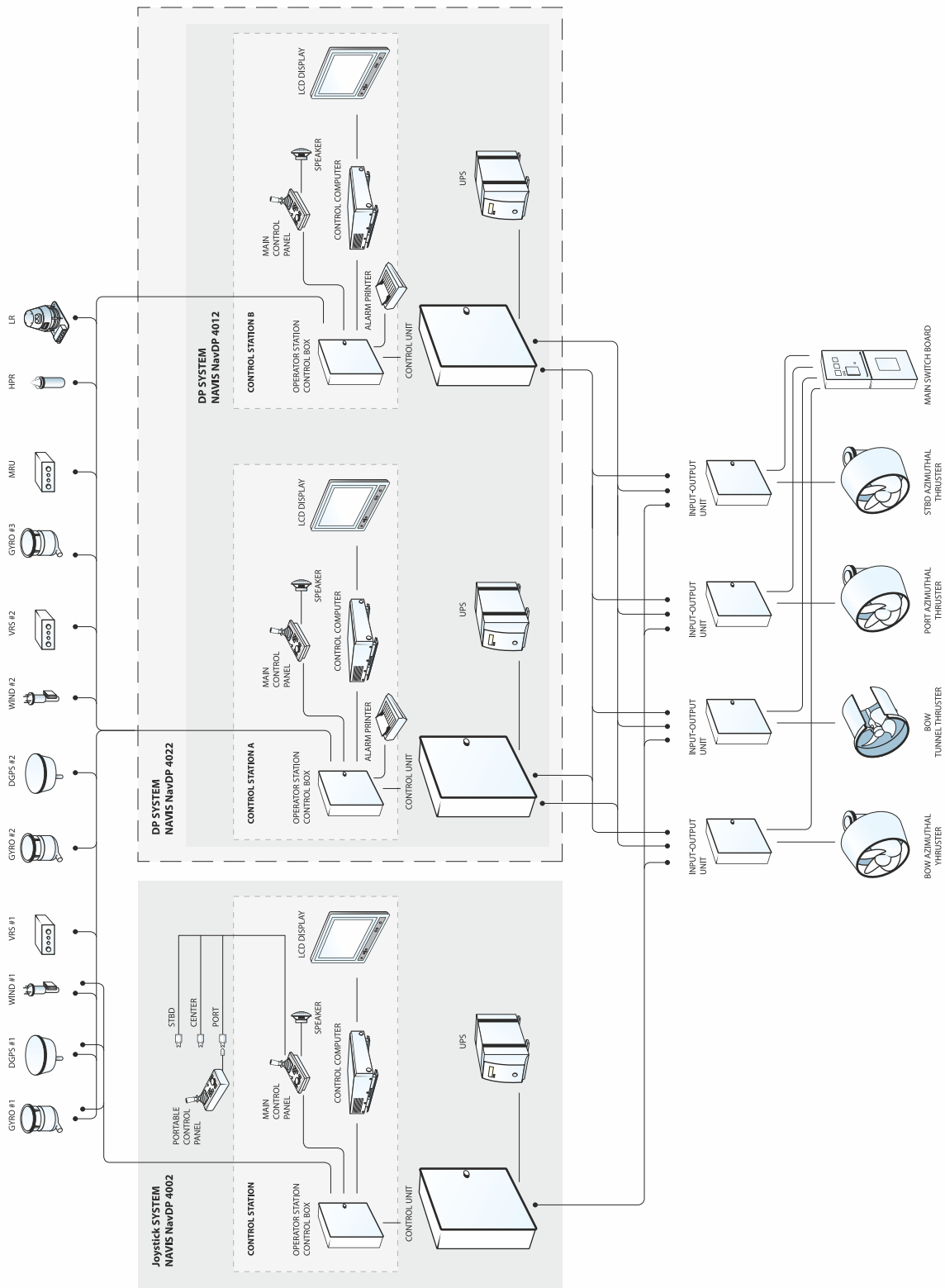

An example of Navis NavDP 4022/02 DP system configuration

Turn-Key Solutions



Working in close cooperation with all the major Classification Societies (DNV, ABS, Lloyd's Register, BV), our project team ensures that every system we supply will receive optimum Class approval.

The Navis Group provides reliable follow up within a whole project period, which ensures that a customer gets a complete turn-key solution.

We provide:

- Initial ship inspection
- Project services
- Class approval
- Logistic support
- Commissioning of a system
- Sea Trials
- Crew Training

The use of extensive testing allows us to reveal all possible problems and errors which may occur during installation and commissioning. This minimizes the amount of time and effort spent during installation, reducing costs as well. Testing is performed using high-precision, realistic models of the sea environment and the motion of the vessel.



CREW TRAINING

Navis Engineering provides a multi-level solution for training. It ranges from the stand-by simulator mode available in every DP we supply up to the full-scale DP Training class simulator, Navis-MTC DPS Trainer C4/2, used for DP operator training in the training centers accredited by the Nautical Institute of London, as well as for crew briefing in ship-owners' offices.

At present, Navis' DP simulators are installed in 20 Nautical Institute accredited training centers around the world, either as part of the full-mission bridge simulator or as an independent DP training facility.

Wherever you are on the globe, Navis Engineering offers you a comprehensive package of technical support 24/7 x 365 days a year. The combination of extensive built-in diagnostics, hot-line support, a network of service agents with Navis Engineering certified field service engineers, and our service centers with senior engineers ready to fly to your vessel within 24 hours, no matter where it is located, ensures a timely response to any technical problem.

The Navis Service Center in Helsinki provides prompt of service agents and partners to accomplish what needs to be done.



Navis Engineering Service Center contact information (Dynamic Positioning Systems):

Phones: +358 9 2316 4430 (Finland), +1 504 613 0200 (USA)
E-mail: dpsupport@navisincontrol.com, ivcs@navisincontrol.com



Headoffice Navis Engineering Oy Tuupakantie 3A, FI 01740 Vantaa, Finland Tel:+358 9 250 9011 Fax:+358 9 250 9012
R&D Center Navis Ltd. Detskaya str., 5a, 199106 Saint-Petersburg, Russia Tel:+7 812 322 67 15 Fax: +7 812 322 67 35
Navis Singapore Level 28 Gateway East, 152 Beach Road, Singapore, 189721 Tel: +65 6827 5645 Fax: +65 6295 2567

www.navisincontrol.com, sales@navisincontrol.com